

# PAR 56 LANTERNS

Par 56 lanterns are supplied with integral wire mesh, cable grip gland, lamp retaining ring, and color frame retainers (gel clips). This lantern can be supplied with a UL listing if specified upon ordering.

Standard finishes are semi-matt black or silver (with black interior.) Other finishes will be priced on application. A RAL or BS color number is required for identification of custom finish.

Par lanterns can be fitted with several types of lamps at competitive prices. Special lanterns (priced on application) can be supplied to suit customer requirements.

DIMENSIONS (ins)				
DESCRIPTION	LENGTH	WIDTH	HEIGHT (NOT INCLUDING YOKE)	TOP OF YOKE TO PIVOT POINT
PAR 56 STANDARD	14.17	9.8	8.78	7.32
PAR 56 SHORT NOSE	10.43	9.8	8.78	7.32
PAR 56 FLOORLITE	10.43	9.8	8.78	8.34
PAR 64 / 56	13.66	10.47	9.37	8.7

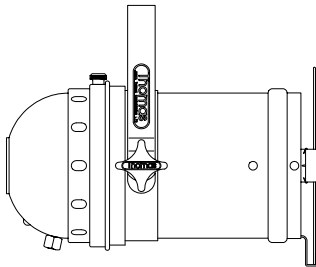

PAR 56 STANDARD			WT lbs
BLACK	SILVER	COLOR	
A5600	A5601	A5602	3.35

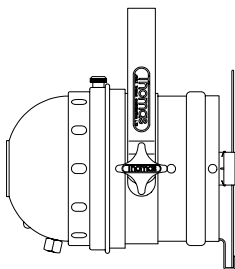

PAR 56 SHORT NOSE			WT lbs
BLACK	SILVER	COLOR	
A5603	A5604	A5605	3.05

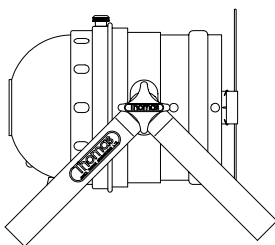

PAR 56 FLOORLITE			WT lbs
BLACK	SILVER	COLOR	
A5606	A5607	A5608	3.66

## ACCESSORIES FOR PAR 56 LANTERNS

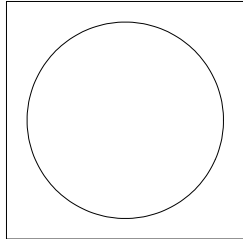

PRODUCT CODE	DESCRIPTION	SIZE INCHES (MM)	WT lbs
D5650	SQUARE COLOR FRAME BLACK	9" X 9" (229 x 229)	0.24
D5651	SQUARE COLOR FRAME SILVER		
D5652	SQUARE COLOR FRAME COLOR		

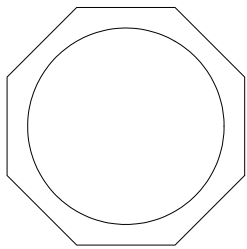

D5656	OCTAGONAL COLOR FRAME BLACK	9" x 9" (229 x 229)	0.22
D5657	OCTAGONAL COLOR FRAME SILVER		
D5658	OCTAGONAL COLOR FRAME COLOR		

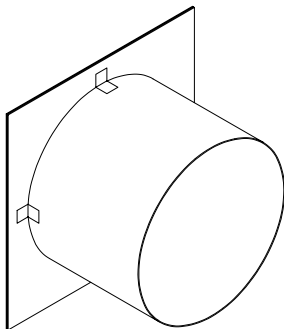

B5603	SPILL RING & COLOR FRAME	9" x 9" x 3.9" (229 x 229 x 100)	0.53
-------	--------------------------	-------------------------------------	------

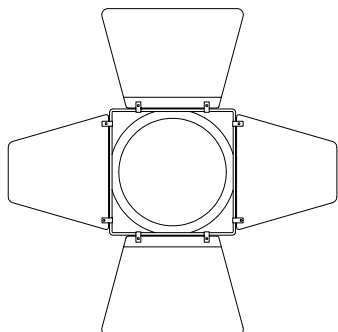

D5660	BARN DOOR 4 WAY BLACK	1.85
D5661	BARN DOOR 4 WAY SILVER	1.85

# PAR 56 LANTERNS

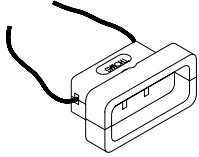

G0000	CERAMIC WITH SHORT TAILS	0.2
-------	--------------------------	-----

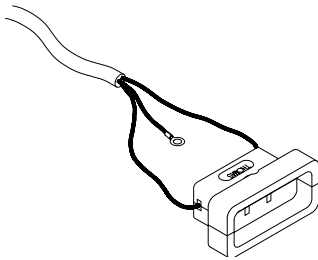

G0001	WIRING SET WITH 36" SILICON CABLE	0.46
-------	-----------------------------------	------

### **RAYLITES:-**

A Range of lightweight bright anodized aluminum reflectors designed to fit in place of par lamps to save weight. Lamp types available are, A1244 240V 500W, DYS 240V 650W, and DYS 120V 600W.

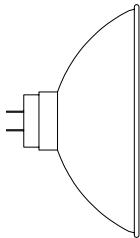

G1003	RAYLITE WITH MOGUL PRONGS - NARROW	0.3
G1004	RAYLITE WITH MOGUL PRONGS - MEDIUM	0.3
G1005	RAYLITE WITH MOGUL PRONGS - WIDE	0.3

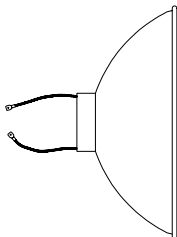

G1009	RAYLITE WITH SHORT TAILS - NARROW	0.26
G1010	RAYLITE WITH SHORT TAILS - MEDIUM	0.26
G1011	RAYLITE WITH SHORT TAILS - WIDE	0.26